

Silicon Switching Diodes

- High-speed, high-voltage switching applications

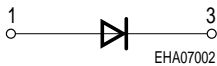
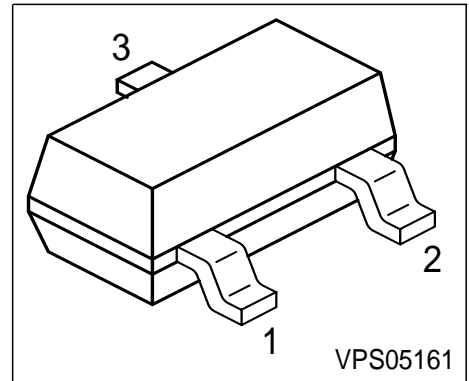

Type	Marking	Pin Configuration			Package
		1 = A	2 = n.c.	3 = C	
BAS19	JPs	1 = A	2 = n.c.	3 = C	SOT23
BAS20	JRs	1 = A	2 = n.c.	3 = C	SOT23
BAS21	JSs	1 = A	2 = n.c.	3 = C	SOT23

Maximum Ratings

Parameter	Symbol	Value	Unit
Diode reverse voltage	V_R		V
BAS19		100	
BAS20		150	
BAS21		200	
Peak reverse voltage-	V_{RM}		
BAS19		120	
BAS20		200	
BAS21		250	
Forward current	I_F	250	mA
Peak forward current	I_{FM}	625	
Total power dissipation $T_S = 70\text{ °C}$	P_{tot}	350	mW
Junction temperature	T_j	150	°C
Storage temperature	T_{stg}	-65 ... 150	

Thermal Resistance

Parameter	Symbol	Value	Unit
Junction - soldering point ¹⁾	R_{thJS}	≤ 230	K/W

¹⁾For calculation of R_{thJA} please refer to Application Note Thermal Resistance

Electrical Characteristics at $T_A = 25^\circ\text{C}$, unless otherwise specified

Parameter	Symbol	Values			Unit
		min.	typ.	max.	
DC Characteristics					
Breakdown voltage $I_{(BR)} = 100 \mu\text{A}$, BAS19 $I_{(BR)} = 100 \mu\text{A}$, BAS20 $I_{(BR)} = 100 \mu\text{A}$, BAS21	$V_{(BR)}$	120 200 250	- - -	- - -	V
Reverse current $V_R = V_{Rmax}$ $V_R = V_{Rmax}$, $T_A = 150^\circ\text{C}$	I_R	- -	- -	0.1 100	μA
Forward voltage $I_F = 100 \text{ mA}$ $I_F = 200 \text{ mA}$	V_F	- -	- -	1 1.25	V

AC Characteristics

Diode capacitance- $V_R = 0 \text{ V}$, $f = 1 \text{ MHz}$	C_T	-	-	5	μF
Reverse recovery time $I_F = 30 \text{ mA}$, $I_R = 30 \text{ mA}$, measured at $I_R = 3 \text{ mA}$, $R_L = 100 \Omega$	t_{rr}	-	-	50	ns

Test circuit for reverse recovery time

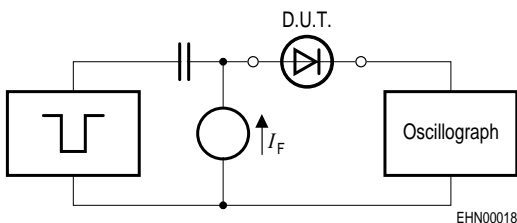

Pulse generator: $t_p = 1 \mu\text{s}$, $D = 0.05$,
 $t_r = 0.6 \text{ ns}$, $R_i = 50 \Omega$

Oscilloscope: $R = 50 \Omega$, $t_f = 0.35 \text{ ns}$, $C \leq 1 \text{ pF}$

Reverse current $I_R = f(T_A)$

$V_R =$ Parameter

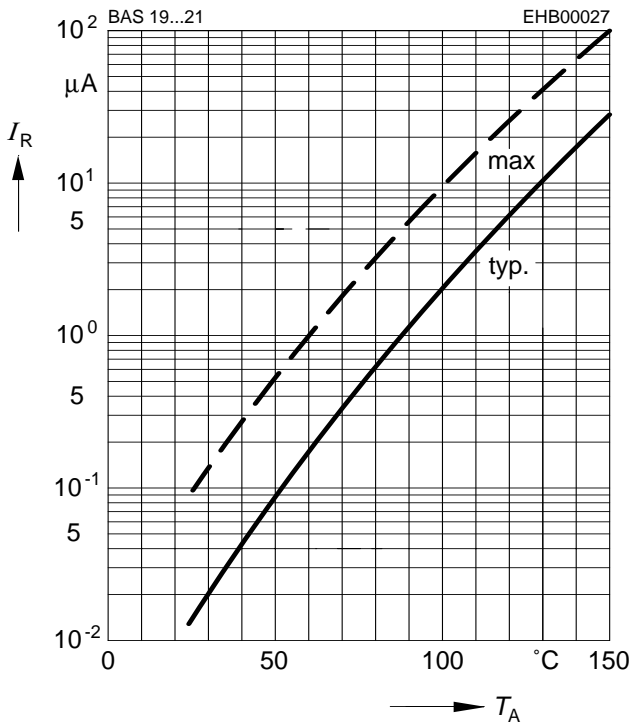

Forward Voltage $V_F = f(T_A)$

$I_F =$ Parameter

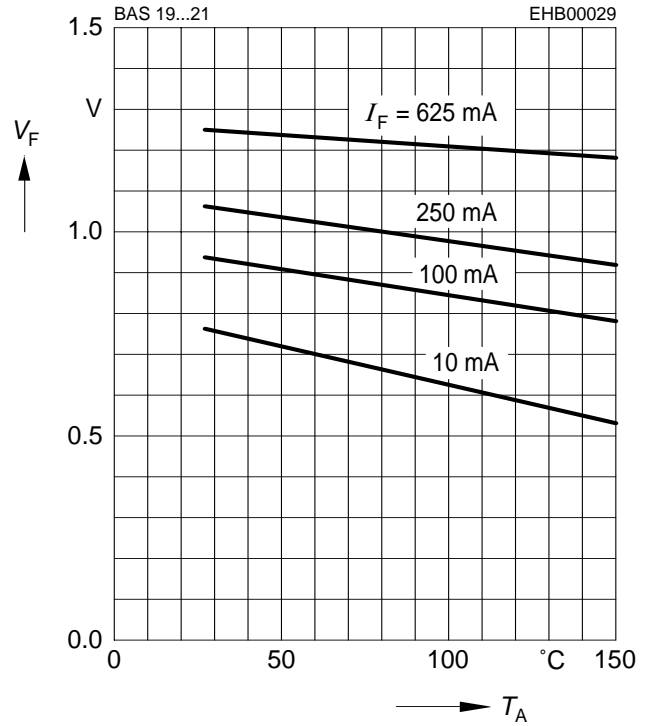

Forward current $I_F = f(V_F)$

$T_A = 25\text{ °C}$

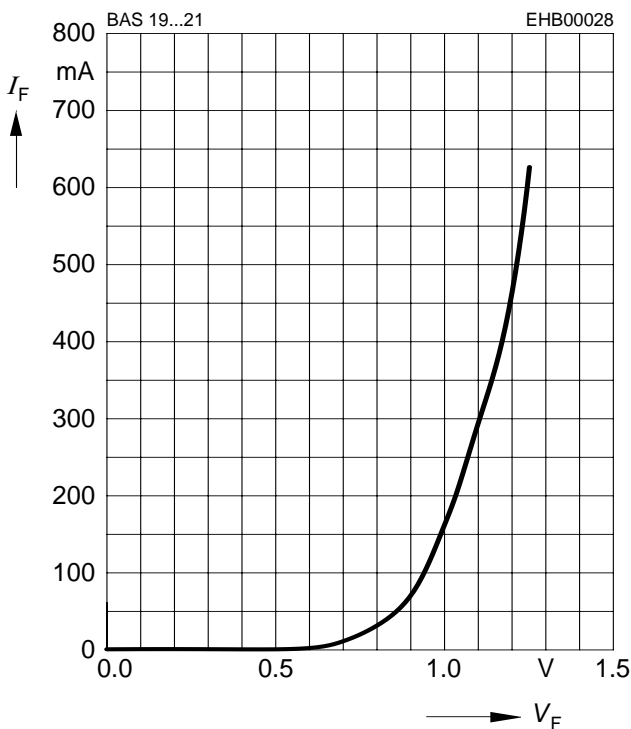

Peak forward current $I_{FM} = f(t_p)$

$T_A = 25\text{ °C}$

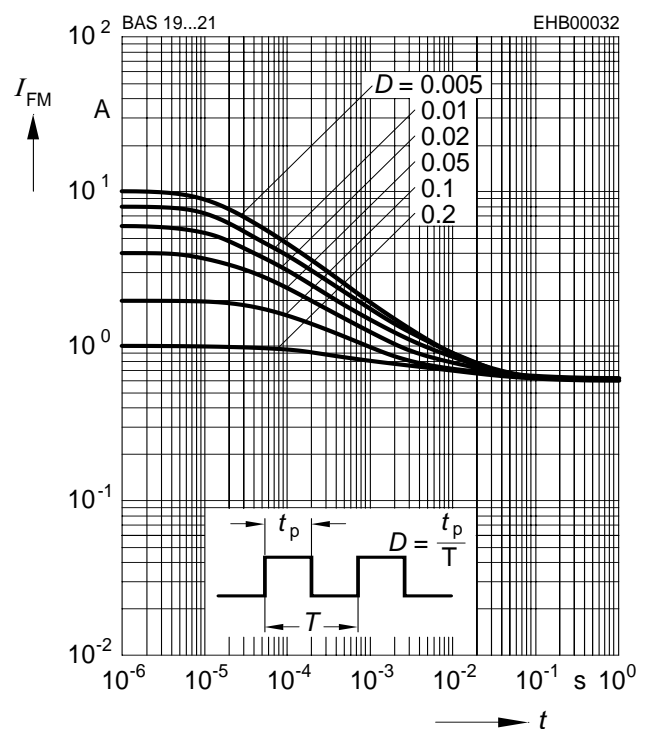

Reverse voltage $V_R = f(T_A)$

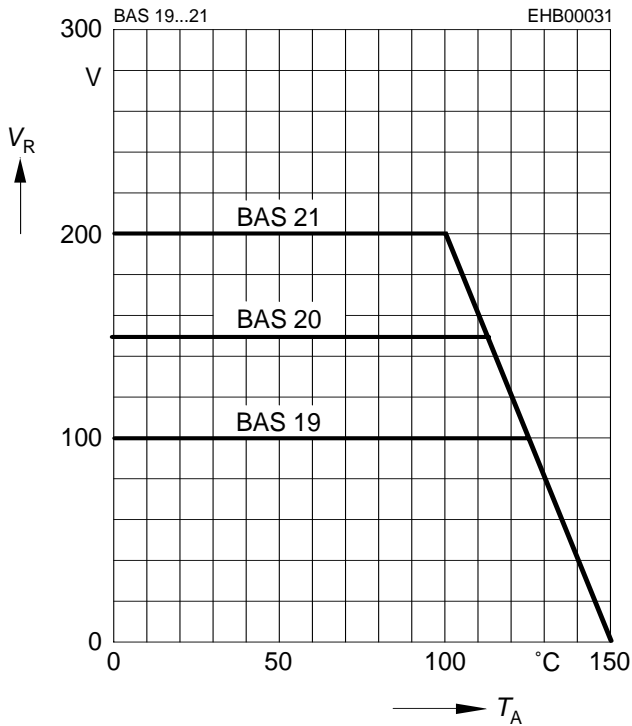

Permissible Pulse Load

$I_{Fmax} / I_{FDC} = f(t_p)$

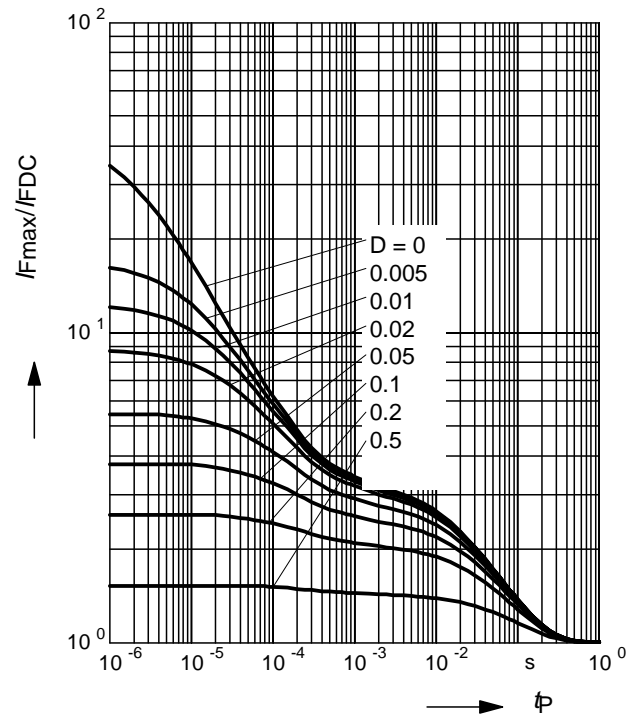

Permissible Puls Load $R_{thJS} = f(t_p)$

